

REGULAR DISPLAY AND BUTTON OPERATION

E-01

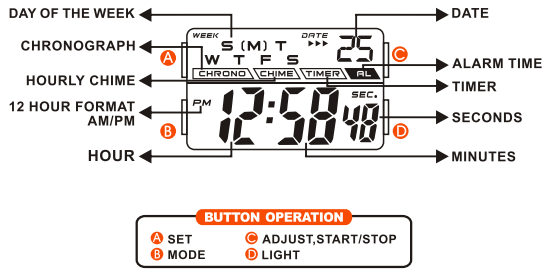

HOW TO CHANGE THE DISPLAY MODE

E-02

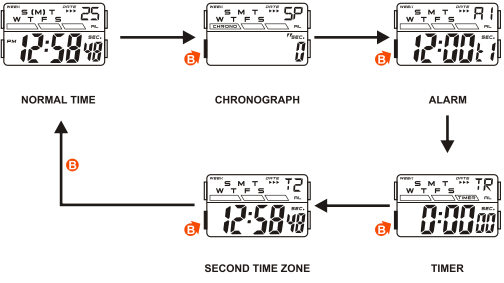

HOW TO DISPLAY CALENDAR

E-03

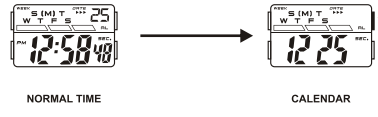

HOW TO SET NORMAL TIME

E-04

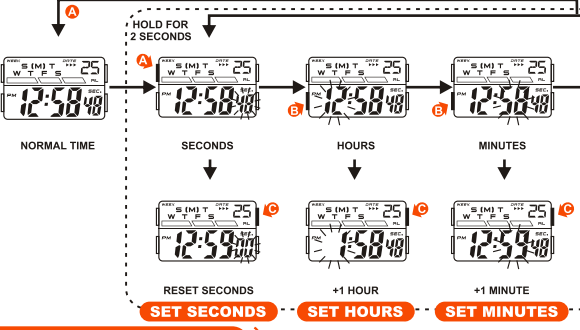

HOW TO SET NORMAL TIME

E-05

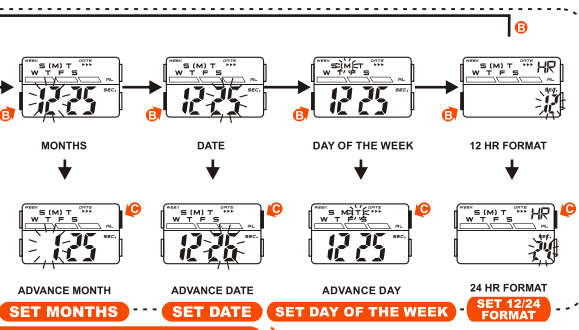

HOW TO SET ALARM TIME

E-06

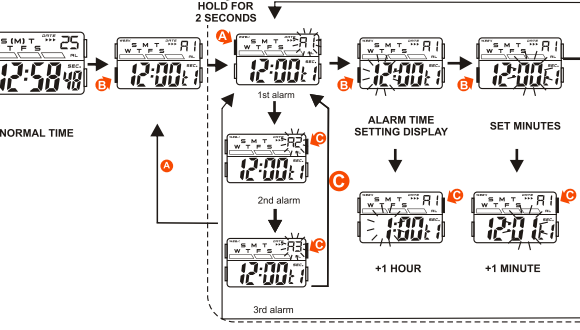

HOW TO SET ALARM TIME

E-07

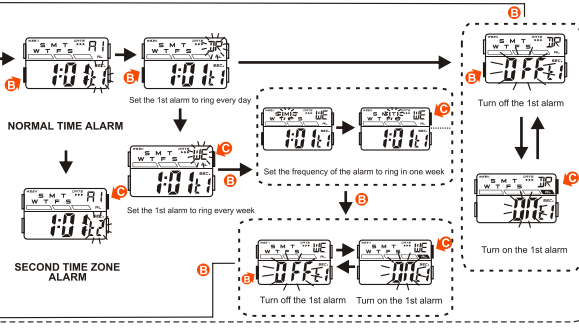

How to set the alarm, ringing on the hour and key tone

E-08

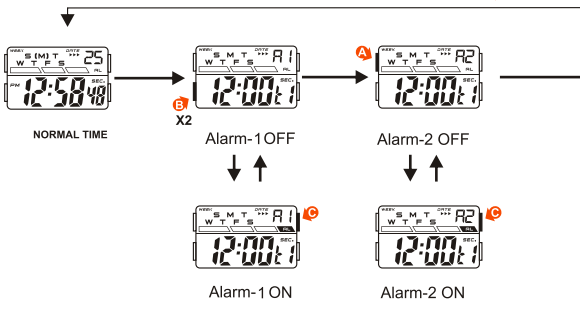

How to set the alarm, ringing on the hour and key tone

E-09

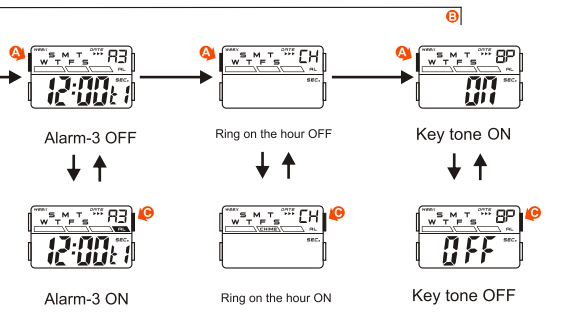

HOW TO USE THE CHRONOGRAPH

E-10

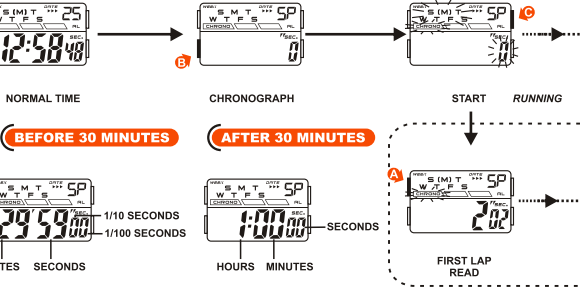

HOW TO USE THE CHRONOGRAPH

E-11

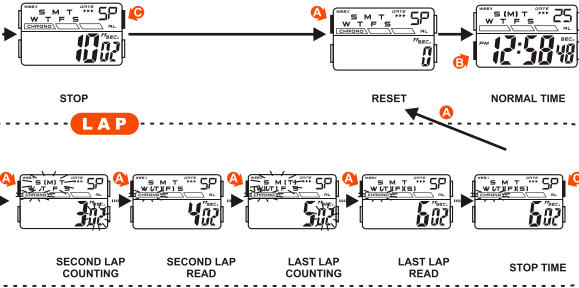

SET TIMER

E-12

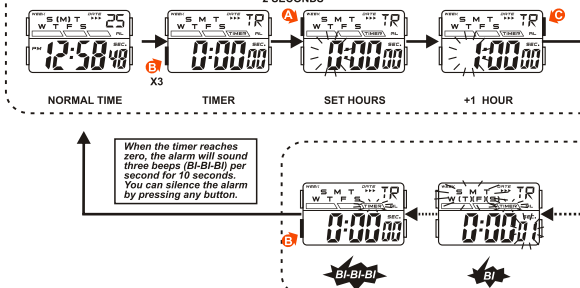

HOW TO USE EL LIGHT

E-13

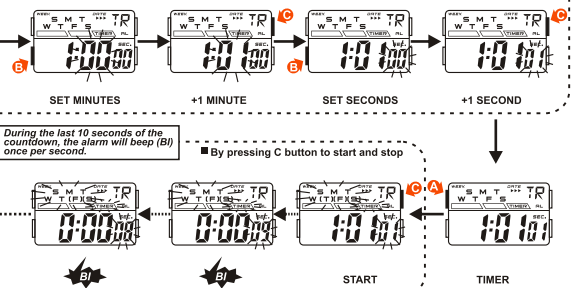

HOW TO SET SECOND TIME ZONE

E-14

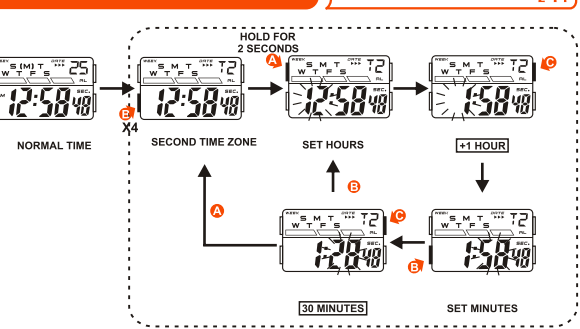

CARE OF YOUR WATCH

E-16

1. This watch contains precise electronic components. Never attempt to open the case or remove the back cover.
2. Do not operate buttons while underwater, or while swimming or diving.
3. Should water or condensation appear in the watch, immediately have the watch checked. Water can corrode electronic parts inside the case.
4. Avoid severe impact: The watch is designed to withstand impact under normal use. Do not subject it to severe impacts or rough usage, and do not drop it onto hard surfaces.
5. Avoid exposing the watch to temperature extremes.
6. Clean the watch with a soft cloth and clean water only. Avoid using chemicals, especially soap.
7. Keep your watch away from strong electric fields and static electricity.

FEATURES AND SPECIFICATIONS

E-17

1. Standard display mode: Hour, Minutes, Seconds, Month, Day of the week.
2. Function:
 - * Month, Date AM/PM and Electro-Luminescent light.
 - * Alarm function with buzzer signal output.
 - * Chronograph function with lap operation.
 - * Hourly chime.
 - * 12/24 hour format switch option.
 - * Timer.
 - * Second time zone.
3. Accuracy at normal temperature (25°C): ± 30 seconds a month.
4. Normal operating temperature range: 10°C ~ 40°C.

**GUARANTEE CERTIFICATE
CERTIFICAT DE GARANTIE**

MODEL: _____
MODELE: _____

DATE OF PURCHASE: _____
DATE D'ACHAT: _____

OFFICE DEALER STAMP:
TAMPON DU DETAILLANT OFFICIEL: